

GRS Zip-Tek 420

Global Roofing Solutions Zip-Tek 420™

ROOFING LIKE NO OTHER

Talk to **THE SMART ROOF PEOPLE**
www.globalroofs.co.za
marketing@globalroofs.co.za



GRS Zip-Tek 420



Typical Specification

Materials

The roofing shall be Zip-Tek 420 profile roll-formed in continuous lengths in one of the materials in the table below. Zip-Tek 420 is obtained from Global Roofing Solutions.

Material	Steel	Colour One Side	Colour Two Side
Galvanised Z275	ISQ 300	_____	_____
Chromadek® Z200		✓	Special
Zincalume® AZ150	G300	_____	_____
Clean COLORBOND™ AZ150		✓	Special
ZincAL® AZ150	G300	_____	_____
COLORPLUS® AZ150		✓	Special
Aluminium 3004	3004	_____	_____
Color-Tech G4 3004		✓	Special

The Profile

The profile is roll-formed from certified material complying with (select from column in above table). The profile shall have a male and female upstand with an upstanding height of 68mm, which will provide a capillary brake. The nett effective cover width will be 424mm. The male head shall be smaller than the female head.

Assembly

It is recommended that Zip-Tek 420 sheeting should be laid by an approved contractor in strict accordance with the manufacturer's specifications. When using a GRS Approved Contractor, a five year guarantee on site-workmanship and water tightness may be issued after approval by Global Roofing Solutions.

Flashings

Stop endings must be formed at the apex and the pan turned down at the eaves to form a drip. The roof sheeting shall be closed as necessary with purpose-made flashings of a design approved by the supplier. These flashings shall be notched around ribs where necessary. All these operations must be performed with special tools available from the supplier.

Site Handling

Zip-Tek 420 sheets should be suitably supported, clear of the ground, under well ventilated cover, away from risk of damage from building operations, contact with cement, dust, lime and abrasive dust, until required to be installed.

Cleaning Up

The complete roof must be kept clean and free of any swarf and debris.

Quality Assurance

The manufacturer shall be assessed and certified as complying with ISO 9001:2015 Quality Management System.

Solar Clamp

Please refer to GRS PV Clamp brochure.

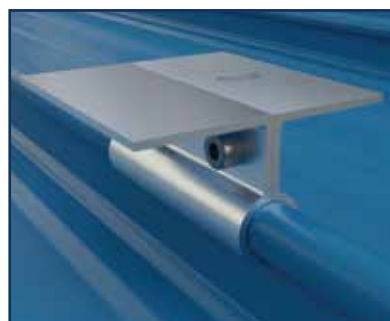

Note

A GRS / Brownbuilt installation warranty will only be honoured if the GRS ZT-PV Clamp is used when installing photovoltaic panels.

The Concealed Fixing Concept

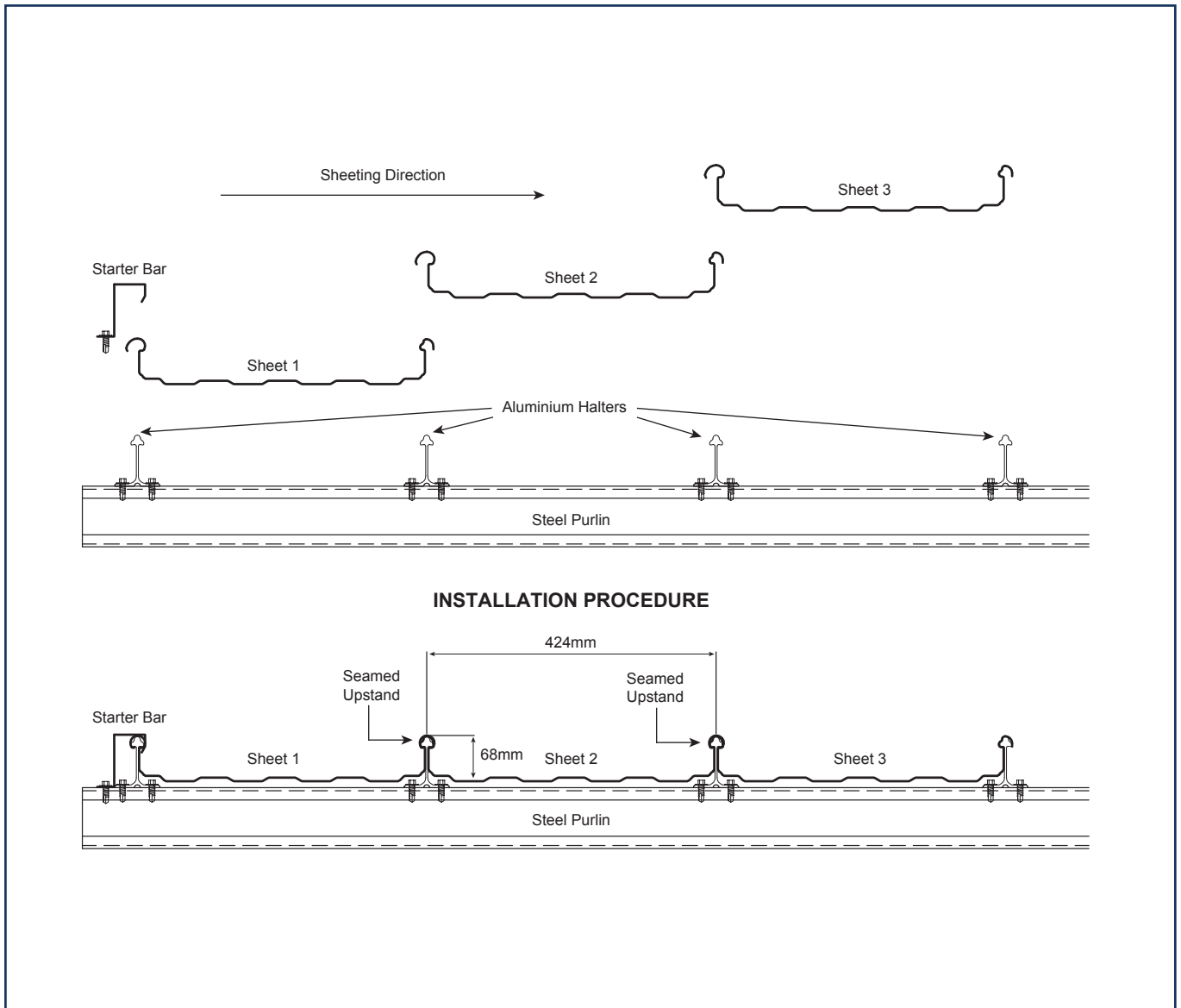

Fasteners

The recommended fasteners for fixing the Zip-Tek 420 halters to steel or timber purlins are as follows:

Steel - (1mm - 4.5mm thick)

No. 12 - 14 x 25mm long self-drilling hex flange head screw No. 3 drill point.

Aluminium

It is recommended that stainless steel fasteners be used in conjunction with aluminium sheeting.

Timber

No. 12 - 11 x 50mm long self-drilling hex flange head screw Type 17 drill point.

Insulation

Please contact GRS for insulation specific fixing details.

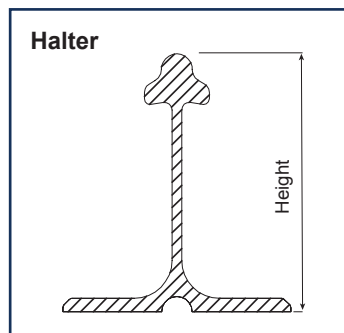

Halter Size	
Height:	110mm
	75mm

Note

Fasteners must be selected to match the life expectancy of the roofing and cladding material. The coating class for fasteners, complying with SANS 1273, should be used in conjunction with all roofing and cladding material.

Additional Applications

Sheet Lengths

Zip-Tek 420 is available, ex-factory, in sheet lengths limited only by transport restrictions; normal loads 12.5m and abnormal loads 18.6m. Longer lengths can be milled on site, eliminating end laps, which are not recommended.

End lapping negates the concealed fix concept and no water tightness guarantee can be issued.

End lapping, due to corrosion, reduces the life expectancy of the roof.

Springing

Zip-Tek 420 can be sprung to a minimum radius of 36m (convex) and 55m (concave), with internal spans of purlins at 1.5m max.

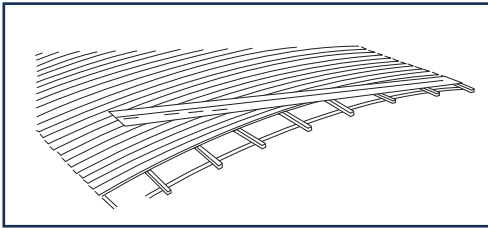

Machine curve (smooth curve) - Aluminium 0.8mm only

Forward (convex) curve min. radii 15m.
Reverse (concave) curved min. radii 29m.

Smooth curving of Zip-Tek 420™ roof sheets

Smooth curving is the forming of the Zip-Tek 420 roof sheet through mechanically curving the sheets using a specifically designed curving roll former.

This process is used to achieve smooth bend radii without creating indentations caused by normal crank curving.

This smooth curved surface compliments modern roofing and cladding designs.

Complex curves (Smooth curve in aluminium)

A single sheet can be forward and reverse-curved to create a wave shape.

Note

It is not possible to smooth curve steel (Galvanised) sheets.

Note

Specific Curved Tapered projects need confirmation.

Bullnosing and Cranking

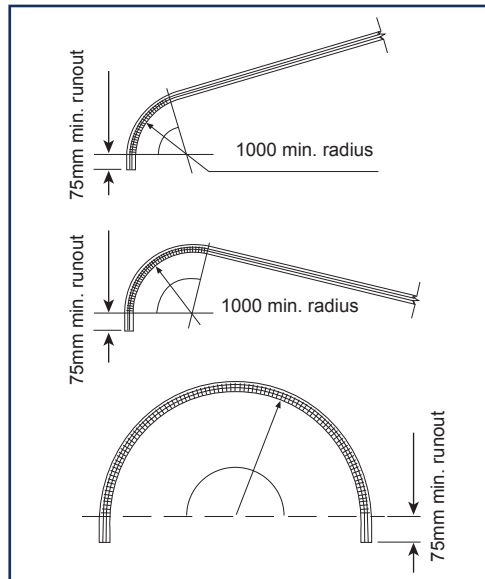

Note

Reverse cranking is not possible.

Note

Consideration for road transport has to be taken into account.

Site cranking for milled sheets is available on application.

Tapered sheets

Tapered Zip-Tek 420 sheets have become increasingly significant for roofing applications as they can be formed into a diverse range of shapes. The minimum and maximum cover widths range between 280mm and 600mm. (When cover widths exceeds 450mm consult GRS as additional support will be required)

Minimum sheet length to be 1500mm long. Tapered Zip-Tek 420 sheets have to be installed on the roof by following the precise instructions laid down in the relevant installation plan. It is advisable to check the actual dimensions of the substructure before producing the tapered sheets.

Note

Both springing and curving of Zip-Tek 420 can result in stresses in the material, resulting in oil canning. Mechanical curving will eliminate the majority of these effects. Care must be taken in checking the structure line of the curve carefully, plus ensuring that all halters are in line. Any discrepancy will affect the line of halters, resulting in poor aesthetics.



Profile: Zip-Tek 420™

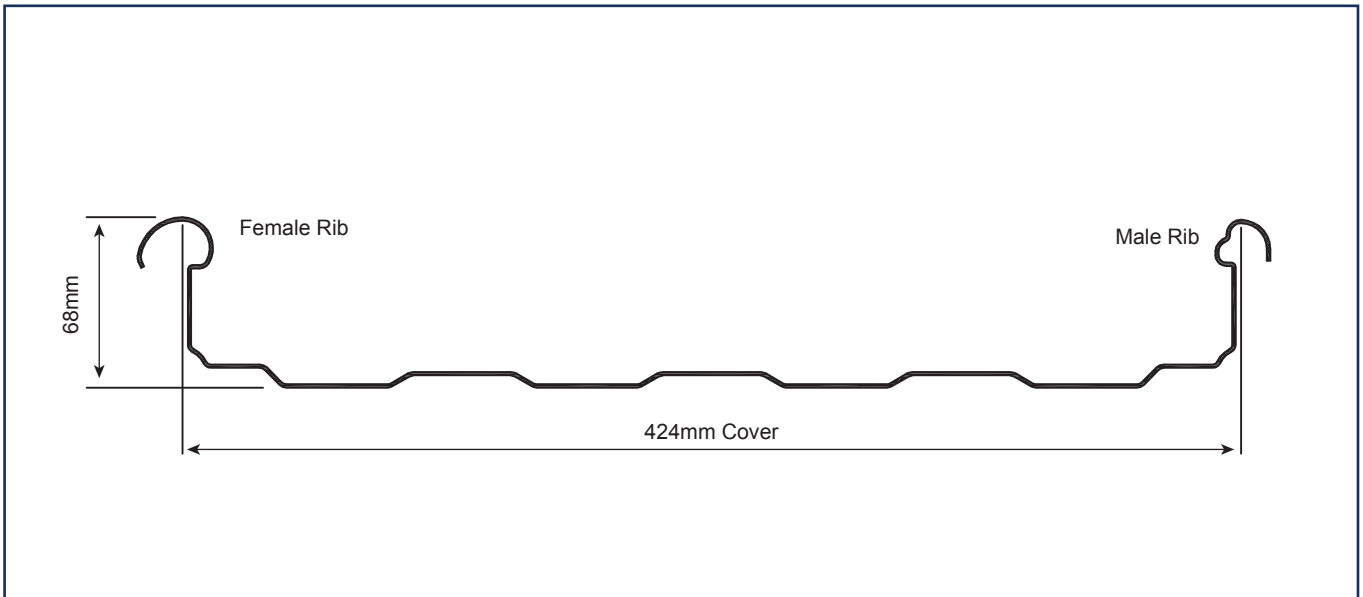

Load Span Table

The recommended purlin support centres are based on the following design criteria and obtained through testing:

	Ultimate Superimposed Distributed Load	Ultimate Uplift Load
ROOFS	1.50 kN/m ²	1.60 kN/m ²
WALLS	0.75 kN/m ²	

Drainage Table

Maximum roof run (in metres) for roof slopes and rainfall intensities shown. These figures are based on unrestricted, free flow of water.

Roof Slope	Rainfall Intensity mm/h				
	200	250	300	400	500
1°	337m	269m	225m	168m	134m
2°	452m	361m	301m	225m	180m
3°		440m	367m	274m	220m
5°			476m	356m	286m

Cantilever Stiffener (424 long)



Note

At 1° slope, all roof supports must be in the same plane as slight variations can result in a zero or negative fall. This may even occur after completion of the building over time. Where possible it is wise to design for a minimum of 2° slope to ensure a positive fall.

Maximum Allowable Support Spacings				
Type of Span	0.53mm	0.55mm	0.58mm	0.8mm Aluminium
Roofs				
End Span	1.900m	1.900m	2.100m	2.200m
Internal Span	2.300m	2.300m	2.500m	2.500m
Cantilever unstiffened	-	-	-	-
Cantilever (stiffened)	0.180m	0.180m	0.260m	0.180m
Nominal Mass kg/m ²	5.8	6.0	6.63	3.13

Available in Galvanised, Zinalume®, Zinal® and Chromadek®, Colorbond™, Colorplus®

Mill Finish, Colour-Tech G4 & PVDF

Spans don't apply to natural sprung sheets. Consult GRS Technical Department.
Spans for timber purlins to be in accordance with SANS 10400

Popular Flashings

Note

Bespoke flashings are generally supplied for Zip-Tek 420. Consult GRS Technical Department.

Available in 0.58mm / 0.8mm thick galvanised Z275 steel, 0.53mm thick Zinalume® AZ150 or 0.55mm thick ZincAL® AZ150. Or with a colour option in Chromadek® (Galvanised Z200), Clean COLORBOND™ (Zinalume® AZ150) or COLORPLUS® (ZincAL® AZ150) finish to one / two sides.

For aluminium available in 0.7mm or 0.8mm thick in mill finish or colour coated.

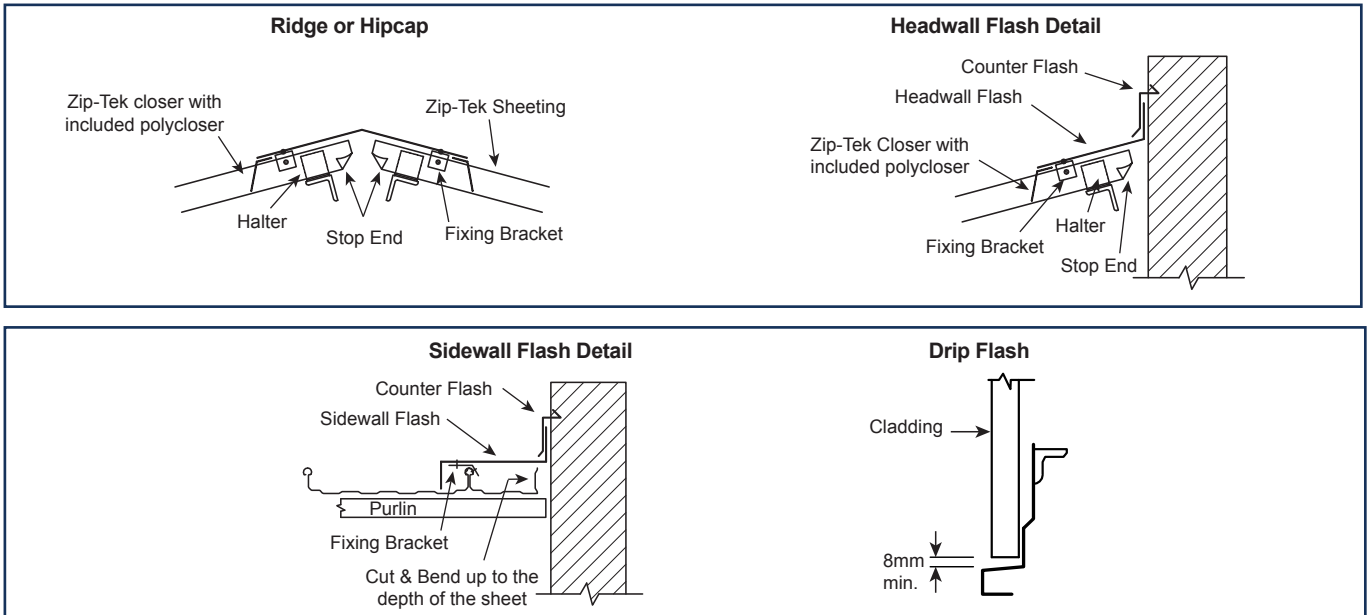

** When sheet lengths are over 30m (20m for aluminium) flashings must be fixed to sheets using sliding brackets.*

Tools

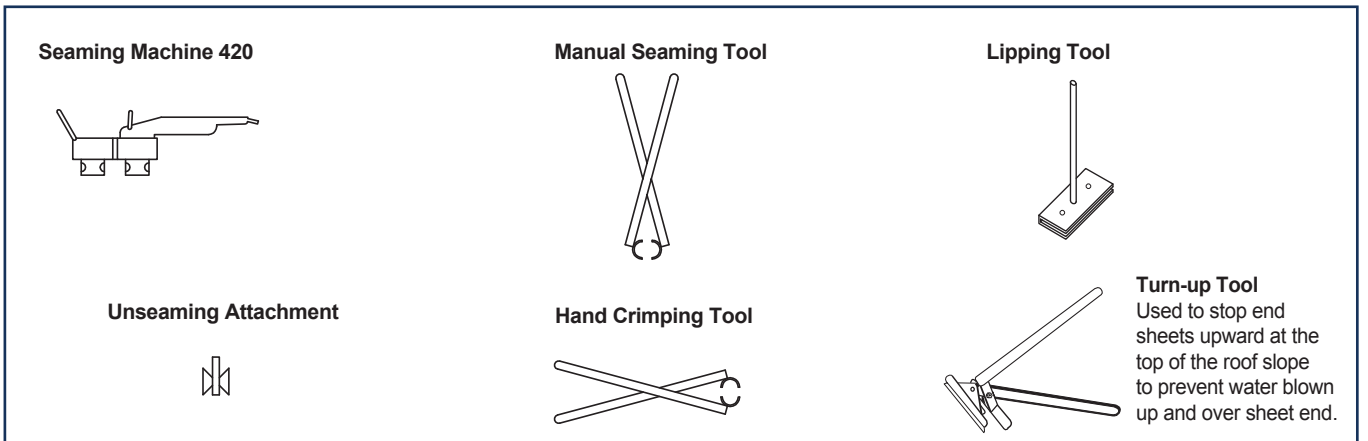

Please visit our website or contact GRS for standard flashing details

Isando	Tel: +27 (0) 11 898 2900	Bloemfontein	Tel: +27 (0) 51 432 3724	Exports	Tel: +27 (0) 11 898 2900	Zambia	Tel: +260 (002) 96 749 5541
Cape Town	Tel: +27 (0) 21 521 1900	Nelspruit	Tel: +27 (0) 13 492 0746/7	Botswana	Tel: +267 (002) 310 5761/2	Zimbabwe	Tel: +263 (002) 477 4699
Durban	Tel: +27 (0) 31 538 0940	Polokwane	Tel: +27 (0) 15 293 0313	Ghana	Tel: +27 (0) 11 898 2976		
Port Elizabeth	Tel: +27 (0) 41 486 1280	Rustenburg	Tel: +27 (0) 14 596 6121	Lesotho	Tel: +266 (002) 22 312 244		
East London	Tel: +27 (0) 43 731 1826	Upington	Tel: +27 (0) 54 332 1657	Namibia	Tel: +264 (002) 61 263 890		



@GRSRoofs

e.&o.e